

V_{DRM}	= 1800	V	<h1>Phase Control Thyristor</h1> <h2>5STP 18F1801</h2>
$I_{T(AV)M}$	= 1825	A	
$I_{T(RMS)}$	= 2867	A	
I_{TSM}	= 26.25×10^3	A	
$V_{(T0)}$	= 0.965	V	
r_T	= 0.17	mW	

Doc. No. 5SYA1062-01 March 05

- Low on-state and switching losses
- Designed for traction, energy and industrial applications
- Optimum power handling capability

Blocking

Maximum rated values ¹⁾

Symbol	Conditions	5STP 18F1801	5STP 18F1601	5STP 18F1401
V_{DRM}, V_{RRM}	$f = 50 \text{ Hz}, t_p = 10 \text{ ms}$	1800 V	1600 V	1400 V
dV/dt_{crit}	Exp. to 1210 V, $T_{vj} = 125^\circ\text{C}$	1000 V/ μs		

Characteristic values

Parameter	Symbol	Conditions	min	typ	max	Unit
Forward leakage current	I_{DRM}	$V_{DRM}, T_{vj} = 125^\circ\text{C}$			150	mA
Reverse leakage current	I_{RRM}	$V_{RRM}, T_{vj} = 125^\circ\text{C}$			150	mA

Mechanical data

Maximum rated values ¹⁾

Parameter	Symbol	Conditions	min	typ	max	Unit
Mounting force	F_M		20	22	24	kN
Acceleration	a	Device unclamped			50	m/s^2
Acceleration	a	Device clamped			100	m/s^2

Characteristic values

Parameter	Symbol	Conditions	min	typ	max	Unit
Weight	m				0.48	kg
Surface creepage distance	D_s		25			mm
Air strike distance	D_a		13			mm

1) Maximum rated values indicate limits beyond which damage to the device may occur

ABB Switzerland Ltd, Semiconductors reserves the right to change specifications without notice.



On-state

Maximum rated values ¹⁾

Parameter	Symbol	Conditions	min	typ	max	Unit
Average on-state current	$I_{T(AV)M}$	Half sine wave, $T_c = 70^\circ\text{C}$			1825	A
RMS on-state current	$I_{T(RMS)}$				2867	A
Peak non-repetitive surge current	I_{TSM}	$t_p = 10\text{ ms}$, $T_{vj} = 125^\circ\text{C}$, $V_D = V_R = 0\text{ V}$			26.25×10^3	A
Limiting load integral	I^2t				3.45×10^6	A^2s
Peak non-repetitive surge current	I_{TSM}	$t_p = 8.3\text{ ms}$, $T_{vj} = 125^\circ\text{C}$, $V_D = V_R = 0\text{ V}$			28×10^3	A
Limiting load integral	I^2t				3.25×10^6	A^2s

Characteristic values

Parameter	Symbol	Conditions	min	typ	max	Unit
On-state voltage	V_T	$I_T = 2000\text{ A}$, $T_{vj} = 125^\circ\text{C}$			1.3	V
Threshold voltage	$V_{(T0)}$	$I_T = 2200\text{ A} - 6900\text{ A}$, $T_{vj} = 125^\circ\text{C}$			0.965	V
Slope resistance	r_T				0.17	$\text{m}\Omega$
Holding current	I_H	$T_{vj} = 25^\circ\text{C}$		170		mA
		$T_{vj} = 125^\circ\text{C}$		90		mA
Latching current	I_L	$T_{vj} = 25^\circ\text{C}$		450		mA
		$T_{vj} = 125^\circ\text{C}$		350		mA

Switching

Maximum rated values ¹⁾

Parameter	Symbol	Conditions	min	typ	max	Unit
Critical rate of rise of on-state current	di/dt_{crit}	$T_{vj} = 125^\circ\text{C}$, $I_T = I_{T(AV)}$, Cont. $f = 50\text{ Hz}$			200	$\text{A}/\mu\text{s}$
Critical rate of rise of on-state current	di/dt_{crit}	$V_D \leq 1210\text{ V}$, $I_{FG} = 2\text{ A}$, $t_r = 0.3\text{ }\mu\text{s}$ Cont. $f = 1\text{ Hz}$			1000	$\text{A}/\mu\text{s}$
Circuit-commutated turn-off time	t_q	$T_{vj} = 125^\circ\text{C}$, $I_{TRM} = 2000\text{ A}$, $V_R = 200\text{ V}$, $di_T/dt = -12.5\text{ A}/\mu\text{s}$, $V_D \leq 0.67 \cdot V_{DRM}$, $dv_D/dt = 50\text{ V}/\mu\text{s}$		150		μs

Characteristic values

Parameter	Symbol	Conditions	min	typ	max	Unit
Recovery charge	Q_{rr}	$T_{vj} = 125^\circ\text{C}$, $I_{TRM} = 2000\text{ A}$, $V_R = 200\text{ V}$, $di_T/dt = -12.5\text{ A}/\mu\text{s}$		2200		μAs
Gate turn-on delay time	t_{gd}	$V_D = 0.4 \cdot V_{RM}$, $I_{FG} = 2\text{ A}$, $t_r = 0.3\text{ }\mu\text{s}$, $T_{vj} = 25^\circ\text{C}$			2	μs

Triggering

Maximum rated values ¹⁾

Parameter	Symbol	Conditions	min	typ	max	Unit
Peak forward gate voltage	V _{FGM}				12	V
Peak forward gate current	I _{FGM}				10	A
Peak reverse gate voltage	V _{RGM}				10	V
Mean forward gate power	P _{G(AV)}				3	W

Characteristic values

Parameter	Symbol	Conditions	min	typ	max	Unit
Gate-trigger voltage	V _{GT}	T _{vj} = -40 °C			4	V
		T _{vj} = 25 °C			3	
		T _{vj} = 125 °C	0.25		2	
Gate-trigger current	I _{GT}	T _{vj} = -40 °C			500	mA
		T _{vj} = 25 °C			250	
		T _{vj} = 125 °C	10		150	

Thermal

Maximum rated values ¹⁾

Parameter	Symbol	Conditions	min	typ	max	Unit
Operating junction temperature range	T _{vj}		-40		125	°C
Storage temperature range	T _{stg}		-40		125	°C

Characteristic values

Parameter	Symbol	Conditions	min	typ	max	Unit
Thermal resistance junction to case	R _{th(j-c)}	Double-side cooled F _m = 20...24 kN			16	K/kW
	R _{th(j-c)A}	Anode-side cooled F _m = 20...24 kN			25	K/kW
	R _{th(j-c)C}	Cathode-side cooled F _m = 20...24 kN			45	K/kW
Thermal resistance case to heatsink	R _{th(c-h)}	Double-side cooled F _m = 20...24 kN			4	K/kW
	R _{th(c-h)}	Single-side cooled F _m = 20...24 kN			8	K/kW

Analytical function for transient thermal impedance:

$$Z_{th(j-c)}(t) = \sum_{i=1}^n R_{th i} (1 - e^{-t/t_i})$$

i	1	2	3	4
R _{th i} (K/kW)	5.500	7.240	2.000	1.340
τ _i (s)	0.4653	0.1533	0.0375	0.0034

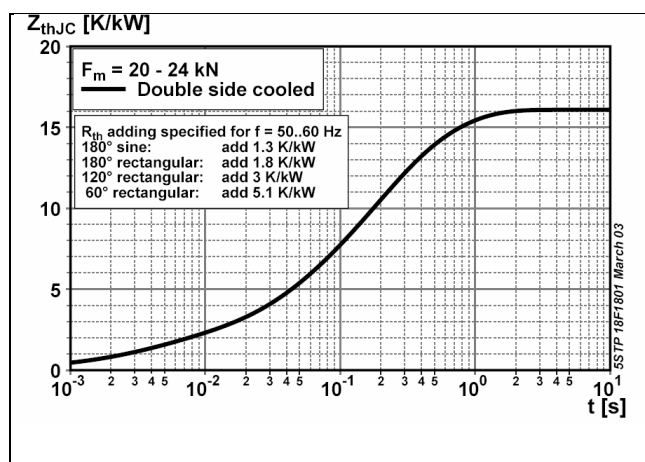

Fig. 1 Transient thermal impedance junction-to case.

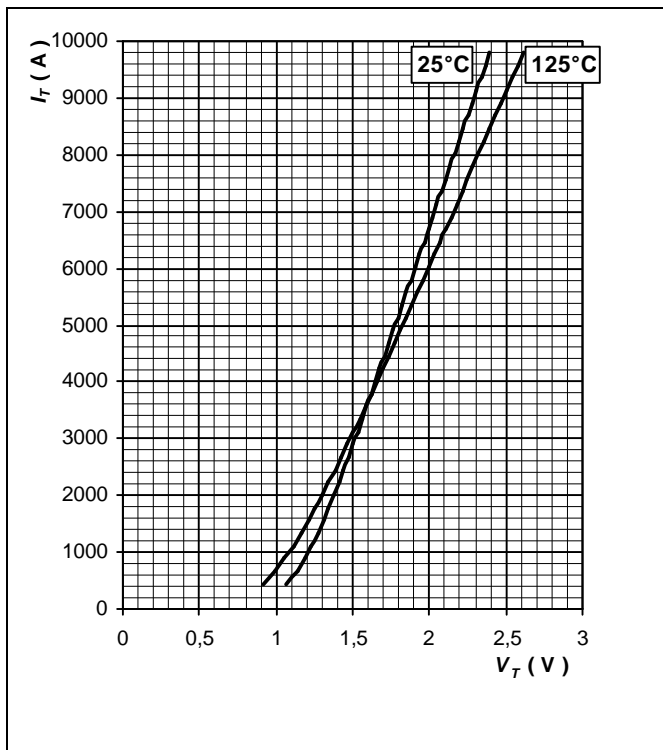

Fig. 2 Max. on-state voltage characteristics

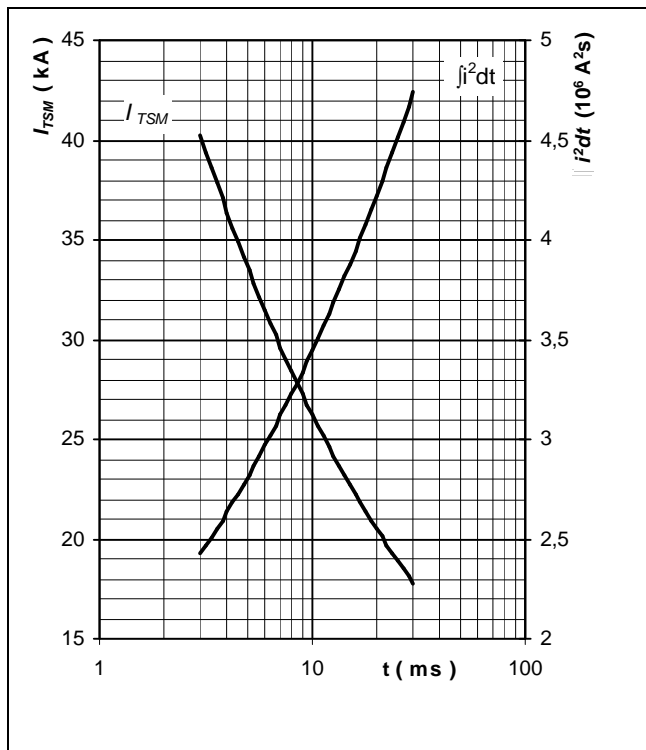

Fig. 3 Surge forward current vs. pulse length. Half sine wave, single pulse, $V_R = 0$ V

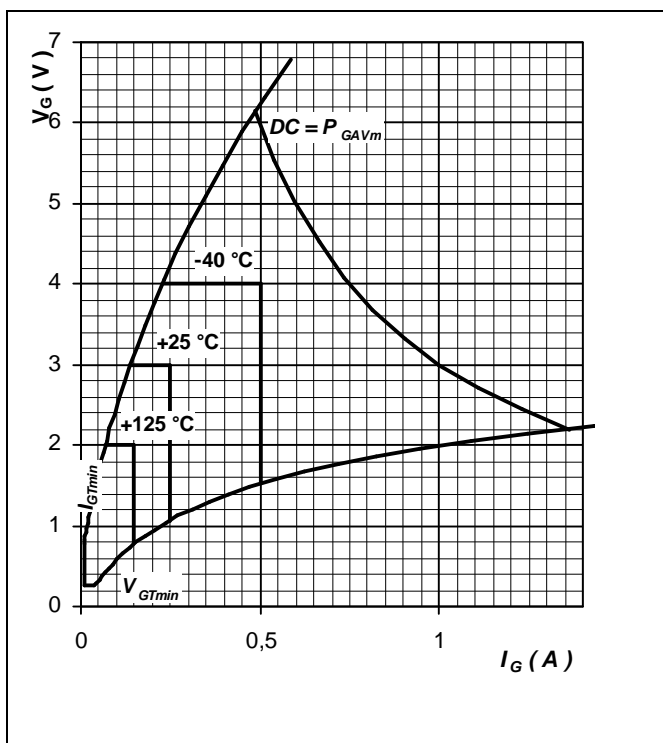

Fig. 4 Gate trigger characteristics

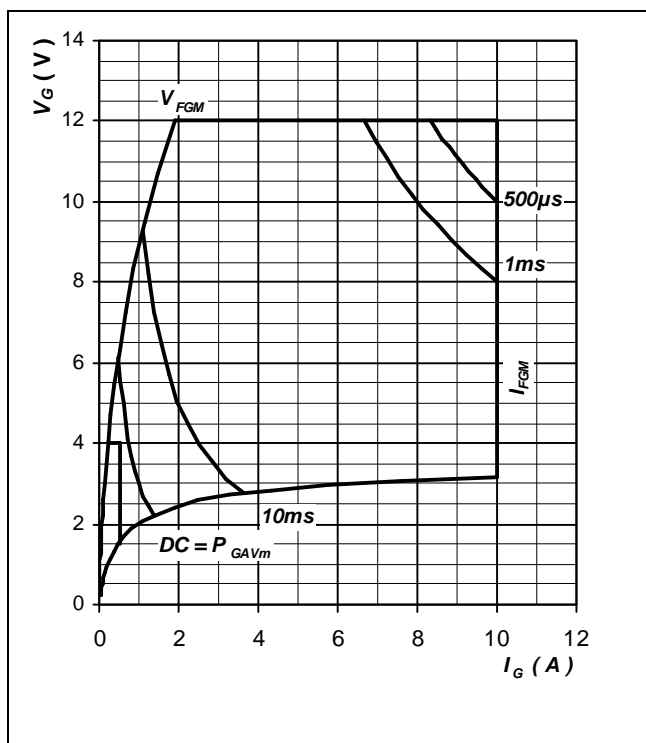

Fig. 5 Gate trigger characteristics

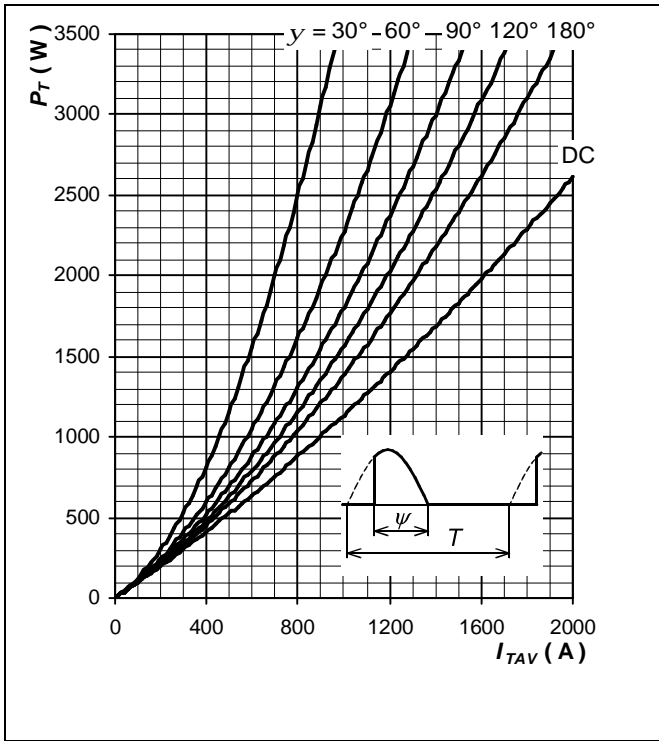

Fig. 6 Forward power loss vs. average forward current, sine waveform, $f = 50 \text{ Hz}$, $T = 1/f$

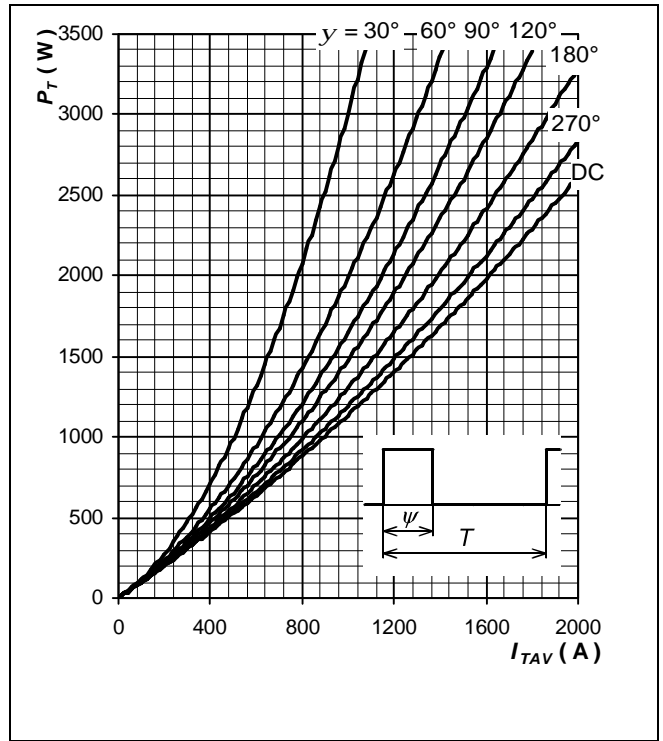

Fig. 7 Forward power loss vs. average forward current, square waveform, $f = 50 \text{ Hz}$, $T = 1/f$

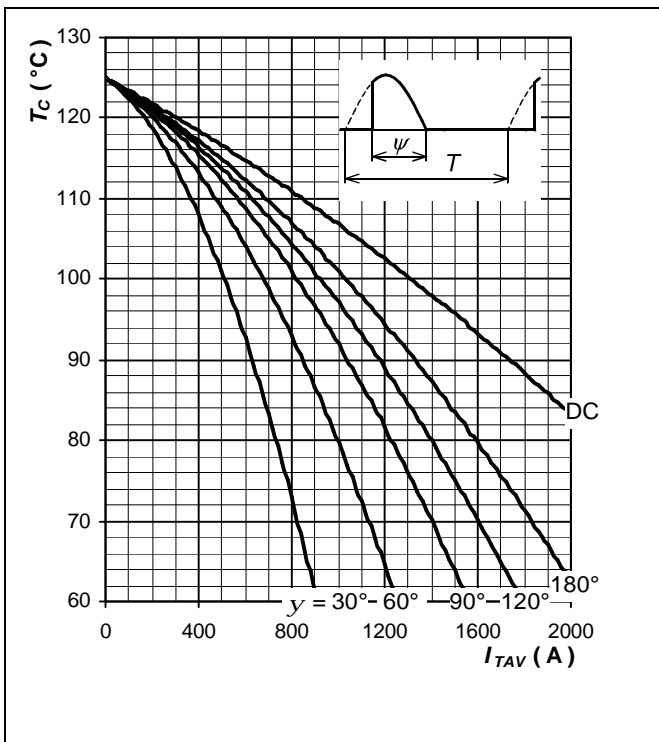

Fig. 8 Max. case temperature vs. average forward current, sine waveform, $f = 50 \text{ Hz}$, $T = 1/f$

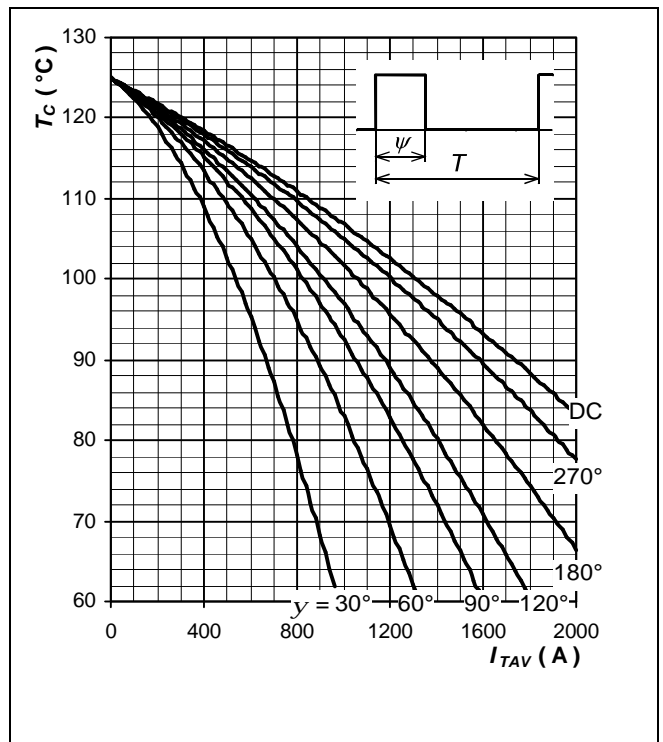

Fig. 9 Max. case temperature vs. average forward current, square waveform, $f = 50 \text{ Hz}$, $T = 1/f$

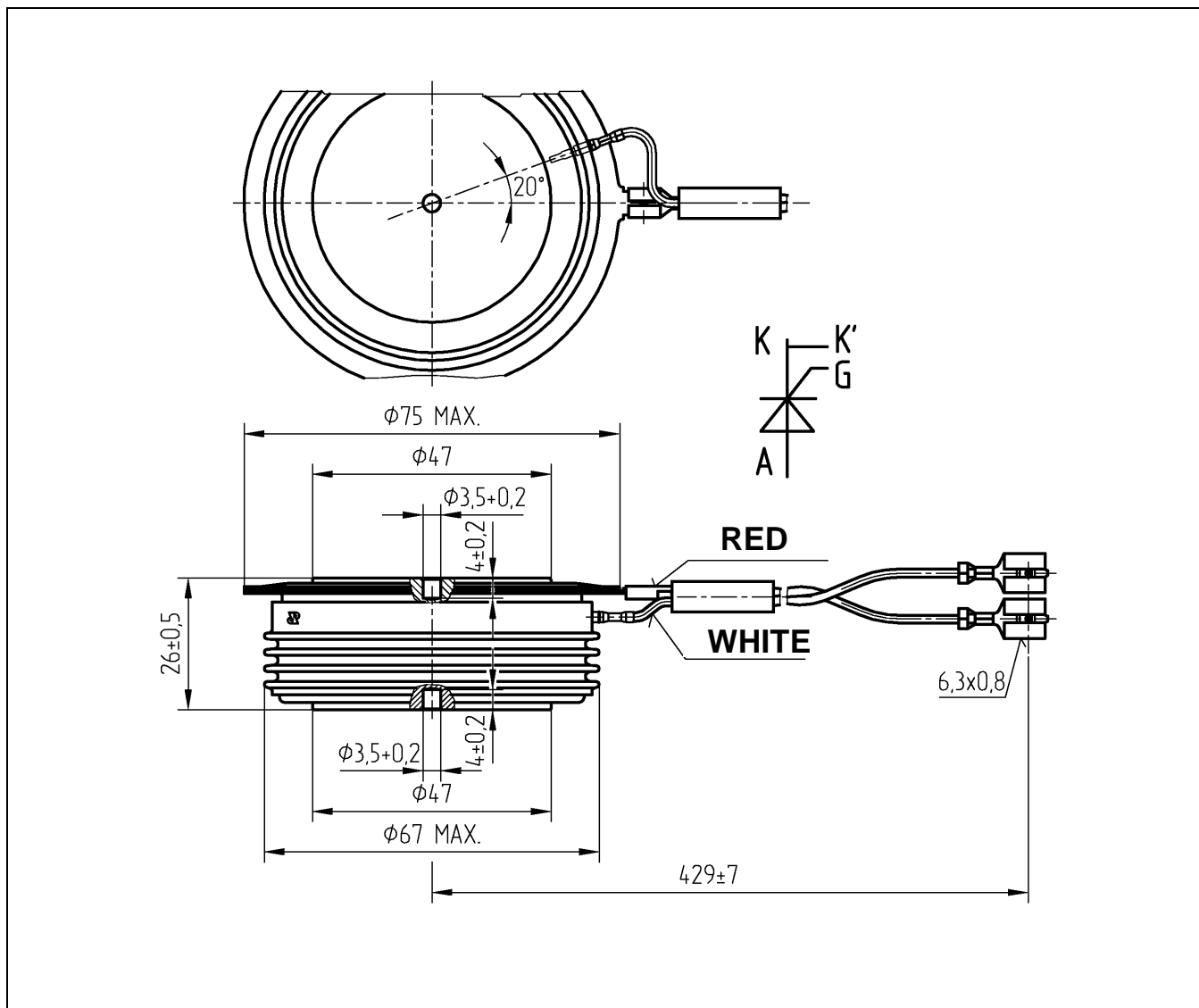

Fig. 10 Device Outline Drawing.

Related application notes:

Doc. Nr	Titel
5SYA2020	Design of RC-Snubber for Phase Control Applications
5SYA2034	Gate-drive Recommendations for PCT's
5SYA 2036	Recommendations regarding mechanical clamping of Press Pack High Power Semiconductors

Please refer to <http://www.abb.com/semiconductors> for actual versions.

ABB Switzerland Ltd, Semiconductors reserves the right to change specifications without notice.



ABB Switzerland Ltd
Semiconductors
Fabrikstrasse 3
CH-5600 Lenzburg, Switzerland

Doc. No. 5SYA1062-01 March 05

Telephone +41 (0)58 586 1419
Fax +41 (0)58 586 1306
Email abbsem@ch.abb.com
Internet www.abb.com/semiconductors